

DM059 - 8 PIECE DOME

NOTE: THIS DOME IS AVAILABLE WITH EITHER EXTERIOR OR INTERIOR SIDE FINISHED

WEIGHT: APX. 250 LBS.

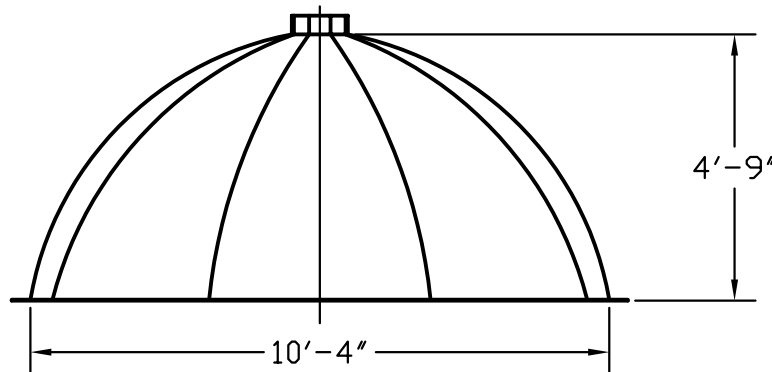

FIBERGLASS  
TECHNOLOGIES, INC.

1610 Hanford St., Levittown, PA \* (215) 943-4567 \* FAX (215) 943-4540

DM059