

BLOCKING AS REQUIRED

BLOCKING DETAIL, CAPITAL

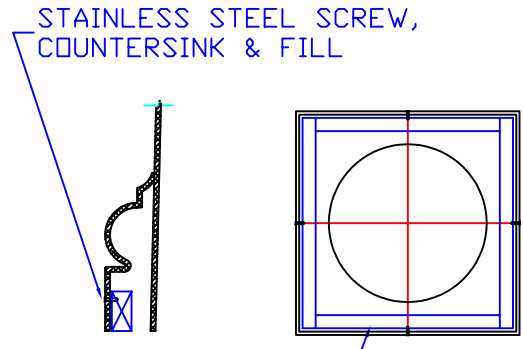

BLOCKING AS REQUIRED

BLOCKING DETAIL, BASE

CAPITAL & BASE
SEPARATE
ALL COLUMNS SHIPPED
IN HALF-UNITS
COLUMN WILL FIT UP TO:
15" SQ. BEAM
Ø21" COLUMN